

**SOT-89-3L Plastic-Encapsulate Transistors**

**B772** TRANSISTOR (PNP)

**FEATURE**

- Low speed switching

**MARKING: B772**

**MAXIMUM RATINGS (T<sub>a</sub>=25°C unless otherwise noted)**

Symbol	Parameter	Value	Unit
V <sub>CB0</sub>	Collector-Base Voltage	-40	V
V <sub>CEO</sub>	Collector-Emitter Voltage	-30	V
V <sub>EBO</sub>	Emitter-Base Voltage	-6	V
I <sub>c</sub>	Collector Current -Continuous	-3	A
P <sub>c</sub>	Collector Power Dissipation	0.5	W
R <sub>θJA</sub>	Thermal Resistance, Junction to Ambient	250	°C/W
T <sub>j</sub>	Junction Temperature	150	°C
T <sub>stg</sub>	Storage Temperature	-55~150	°C

**SOT-89-3L**

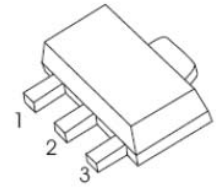

1. BASE
2. COLLECTOR
3. EMITTER

**ELECTRICAL CHARACTERISTICS (T<sub>a</sub>=25°C unless otherwise specified)**

Parameter	Symbol	Test conditions	Min	Typ	Max	Unit
Collector-base breakdown voltage	V <sub>(BR)CBO</sub>	I <sub>C</sub> =-100μA, I <sub>E</sub> =0	-40			V
Collector-emitter breakdown voltage	V <sub>(BR)CEO</sub>	I <sub>C</sub> = -10mA, I <sub>B</sub> =0	-30			V
Emitter-base breakdown voltage	V <sub>(BR)EBO</sub>	I <sub>E</sub> = -100μA, I <sub>C</sub> =0	-6			V
Collector cut-off current	I <sub>CBO</sub>	V <sub>CB</sub> = -40V, I <sub>E</sub> =0			-1	μA
Collector cut-off current	I <sub>CEO</sub>	V <sub>CE</sub> =-30V, I <sub>B</sub> =0			-10	μA
Emitter cut-off current	I <sub>EBO</sub>	V <sub>EB</sub> =-6V, I <sub>C</sub> =0			-1	μA
DC current gain	h <sub>FE</sub>	V <sub>CE</sub> = -2V, I <sub>C</sub> = -1A	60		400	
Collector-emitter saturation voltage	V <sub>CE(sat)</sub>	I <sub>C</sub> =-2A, I <sub>B</sub> = -0.2A			-0.5	V
Base-emitter saturation voltage	V <sub>BE(sat)</sub>	I <sub>C</sub> =-2A, I <sub>B</sub> = -0.2A			-1.5	V
Transition frequency	f <sub>T</sub>	V <sub>CE</sub> = -5V, I <sub>C</sub> =-0.1A f =10MHz	50			MHz

**CLASSIFICATION OF h<sub>FE</sub>**

Rank	R	O	Y	GR
Range	60-120	100-200	160-320	200-400

# Typical Characteristics

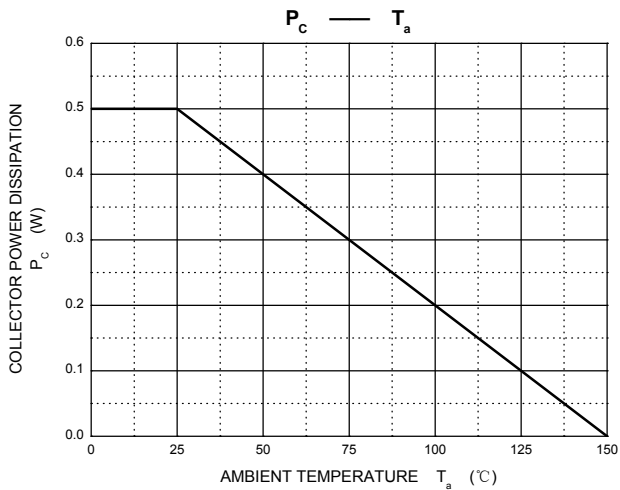
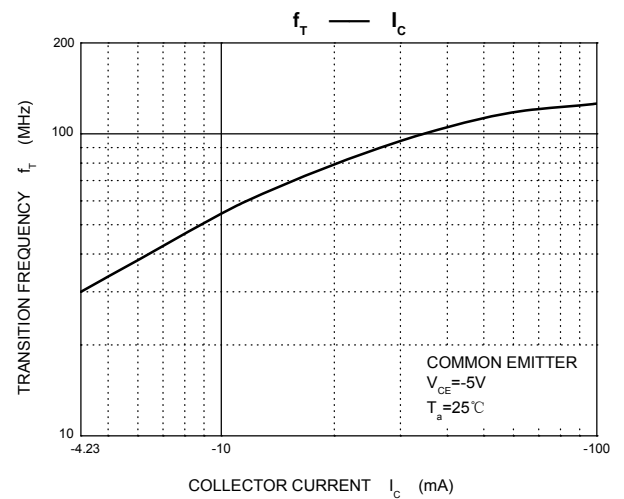
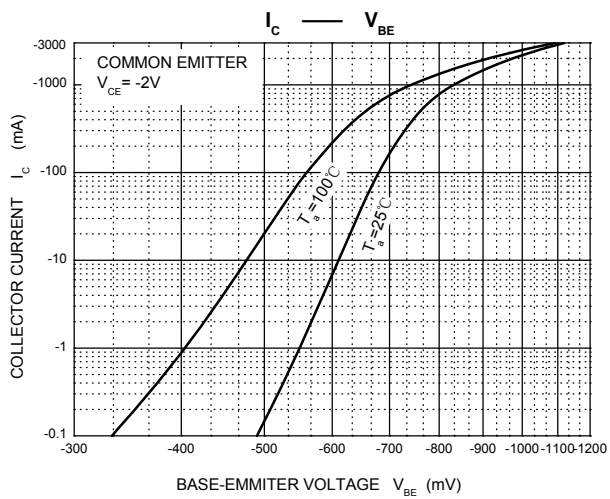
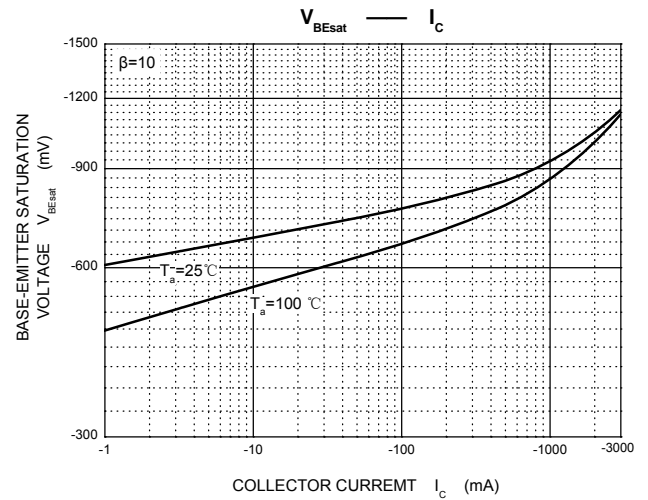
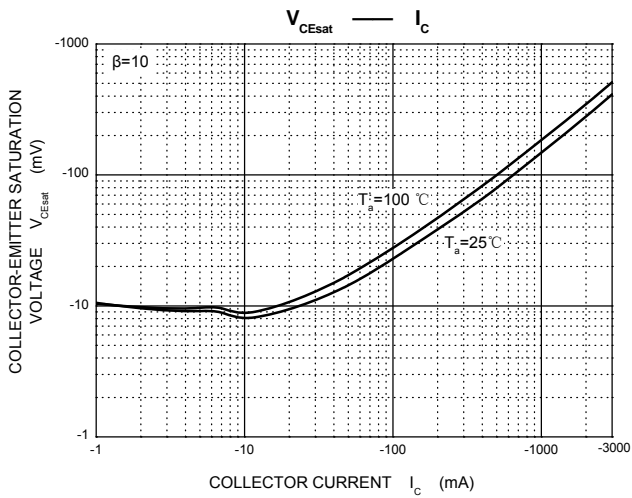
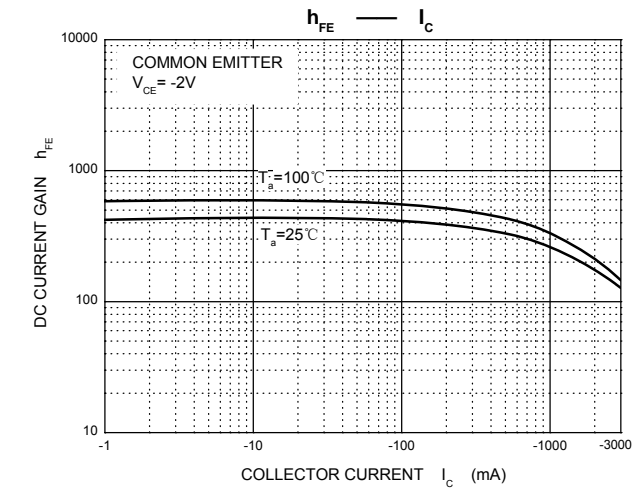
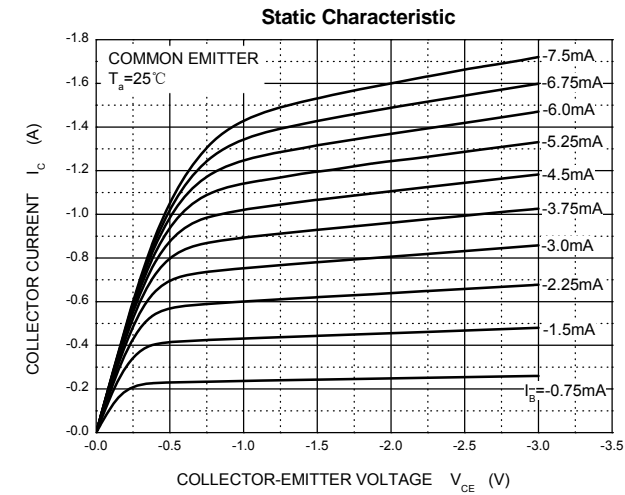

## SOT-89-3L Package Outline Dimensions

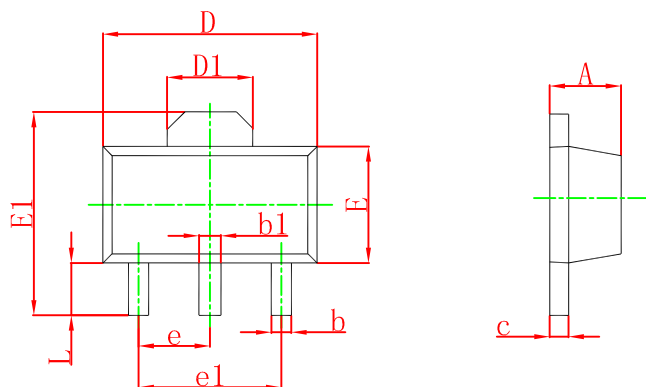

Symbol	Dimensions In Millimeters		Dimensions In Inches	
	Min	Max	Min	Max
A	1.400	1.600	0.055	0.063
b	0.320	0.520	0.013	0.020
b1	0.400	0.580	0.016	0.023
c	0.350	0.440	0.014	0.017
D	4.400	4.600	0.173	0.181
D1	1.550 REF.		0.061 REF.	
E	2.300	2.600	0.091	0.102
E1	3.940	4.250	0.155	0.167
e	1.500 TYP.		0.060 TYP.	
e1	3.000 TYP.		0.118 TYP.	
L	0.900	1.200	0.035	0.047

## SOT-89-3L Suggested Pad Layout

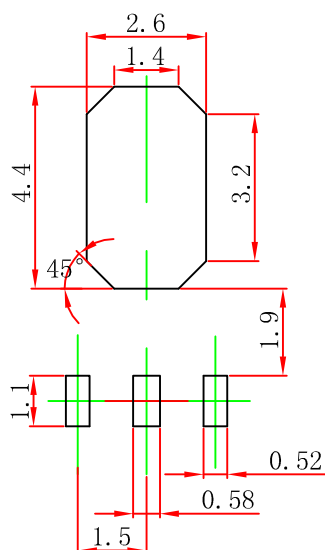

- Note:
1. Controlling dimension: in millimeters.
  2. General tolerance:  $\pm 0.05\text{mm}$ .
  3. The pad layout is for reference purposes only.

### NOTICE

JCET reserve the right to make modifications, enhancements, improvements, corrections or other changes without further notice to any product herein. JCET does not assume any liability arising out of the application or use of any product described herein.

# SOT-89-3L Tape and Reel

## SOT-89-3L Embossed Carrier Tape

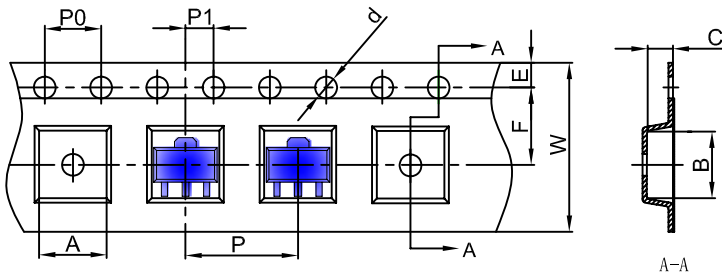

### Packaging Description:

SOT-89-3L parts are shipped in tape. The carrier tape is made from a dissipative (carbon filled) polycarbonate resin. The cover tape is a multilayer film (Heat Activated Adhesive in nature) primarily composed of polyester film, adhesive layer, sealant, and anti-static sprayed agent. These reeled parts in standard option are shipped with 1,000 units per 7" or 18.0 cm diameter reel. The reels are clear in color and is made of polystyrene plastic (anti-static coated).

Dimensions are in millimeter										
Pkg type	A	B	C	d	E	F	P0	P	P1	W
SOT-89-3L	4.85	4.45	1.85	Ø1.50	1.75	5.50	4.00	8.00	2.00	12.00
(Tolerance)	+/-0.1	+/-0.1	+/-0.1	+/-0.1	+/-0.1	+/-0.1	+/-0.1	+/-0.1	+/-0.1	+0.3/-0.1

## SOT-89-3L Tape Leader and Trailer

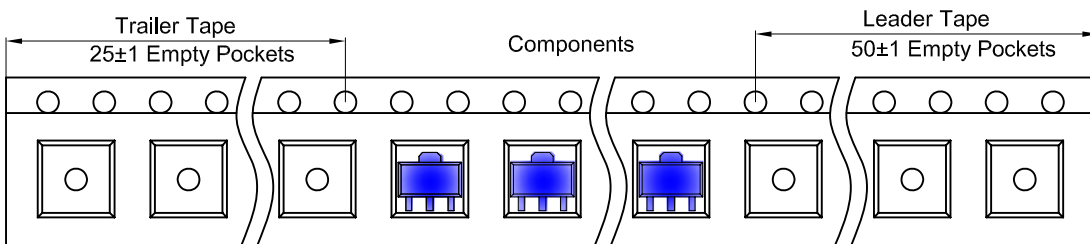

## SOT-89-3L Reel

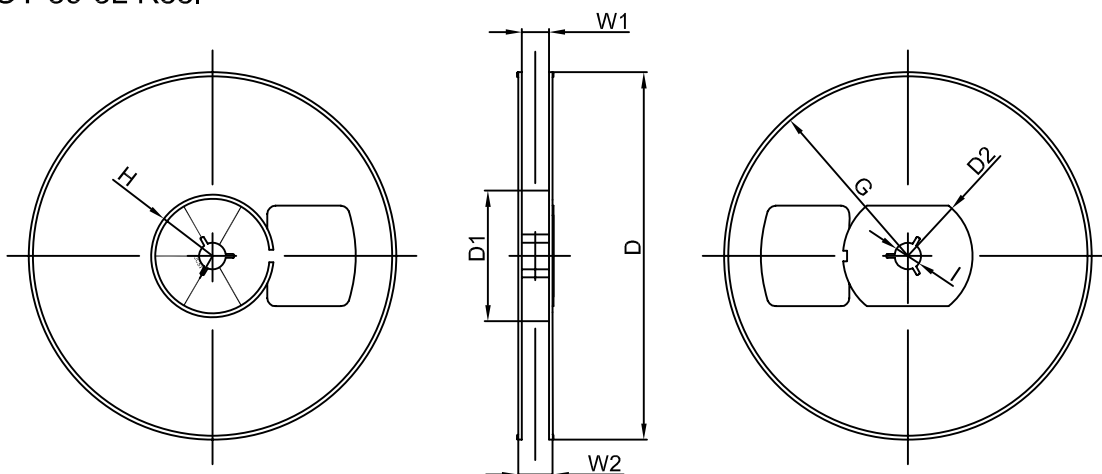

Dimensions are in millimeter								
Reel Option	D	D1	D2	G	H	I	W1	W2
7" Dia	Ø180.00	60.00	R32.00	R86.50	R30.00	Ø13.00	13.20	16.50
Tolerance	+/-2	+/-1	+/-1	+/-1	+/-1	+/-1	+/-1	+/-1

REEL	Reel Size	Box	Box Size(mm)	Carton	Carton Size(mm)	G.W.(kg)
1000 pcs	7 inch	10,000 pcs	203×203×195	40,000 pcs	438×438×220	