

> 产品特点

结构紧凑，安装方便

双极滤波电路，对差模和共模干扰有较高的抑制作用

适用于通用开关电源、UPS、ATM、点钞机、自动售货机、输液及分析仪器、脱脂机、跑步机、加油机、绣花机、工业计算机、控制器、示波器、科学分析仪器等



> 技术指标

额定电压	250AC
额定电流	0.5-200A
工作频率	50/60Hz
耐电压测试	相-相 1700VDC
	相-地 2000VAC

> 产品列表

产品型号	连接方式	额定电流	漏电流	放电电阻	电路图原理图	外形尺寸	重量 (g)
ZJ2B-1	引线	1	<0.5mA	1.5M Ω	fig.1	fig.1	65
ZJ2B-3	引线	3	<0.5mA	1.5M Ω	fig.1	fig.2	95
ZJ2B-6	引线	6	<0.5mA	1.5M Ω	fig.1	fig.2	95
ZJ2B-10	焊片	10	<1mA	1.5M Ω	fig.1	fig.3	100
ZJ2BC-6	焊片	6	<1mA	1.5M Ω	fig.2	fig.3	170
ZJ2BC-10	焊片	10	<1mA	1.5M Ω	fig.2	fig.3	170
ZJ2BC-20	M4 螺栓	20	<1mA	1.5M Ω	fig.2	fig.4	320
ZJ2BC-50	M6 螺栓	50	<2mA	1.5M Ω	fig.2	fig.6	1400
ZJ2BC-100	M8 螺栓	100	<2mA	1.5M Ω	fig.2	fig.7	2000
ZJ2BC-200	M10 螺栓	200	<2mA	1.5M Ω	fig.2	fig.7	3000

> 电路原理图

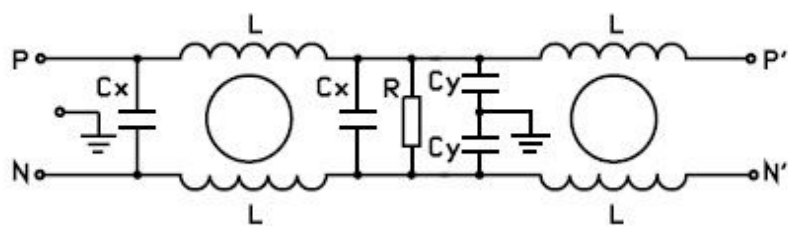

fig.1

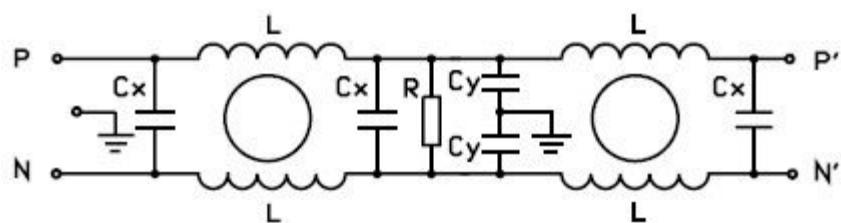

fig.2

> 外形尺寸图

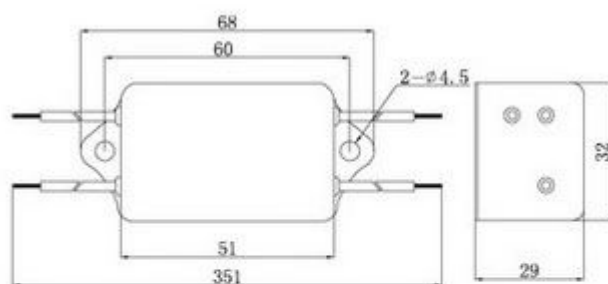
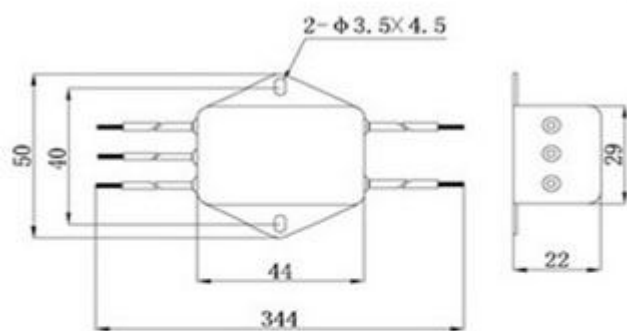

Fig. 2

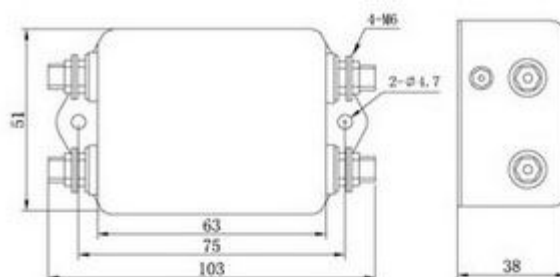
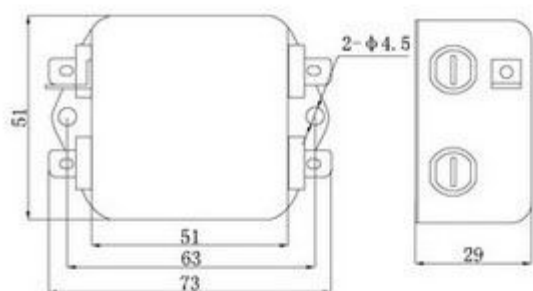

Fig. 4

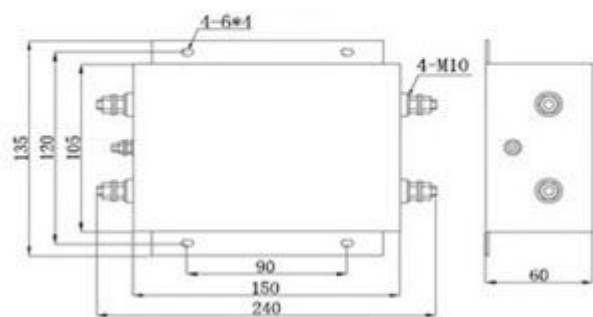

Fig. 5

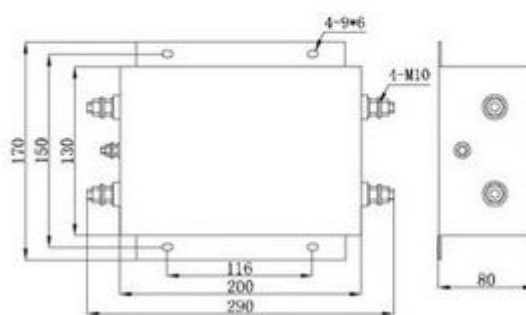
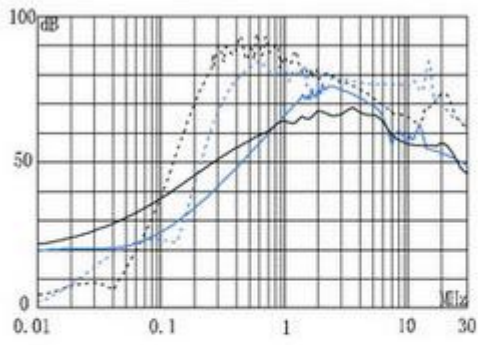

Fig. 6

> 插入损耗图

— 共模 ----- 差模



ZJ2B-1 ZJ2B-3

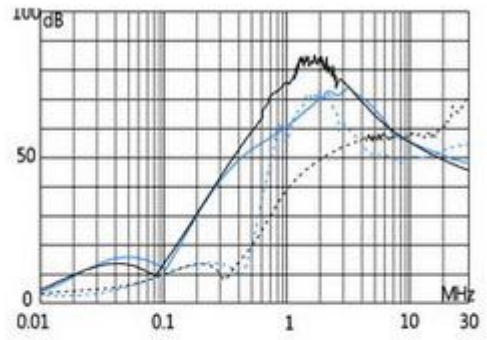

ZJ2B-6 ZJ2B-10

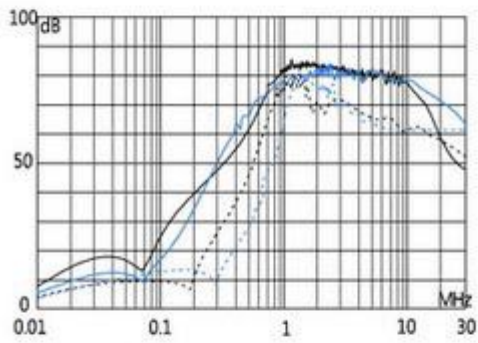

ZJ2BC-6 ZJ2BC-10

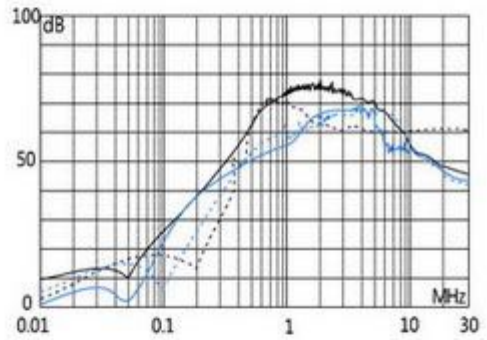

ZJ2BC-20 ZJ2BC-50

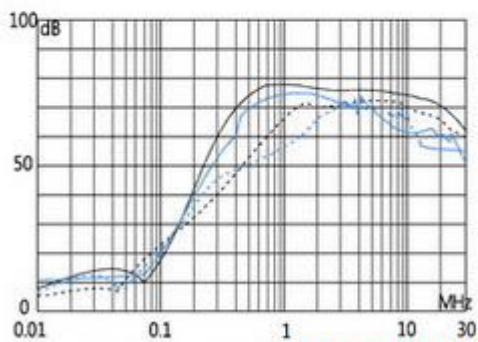

ZJ2BC-100 ZJ2BC-200